

# RKC8.800T-40/TXL

## Actuator and Sensor Cable, PUR – Connection Cable

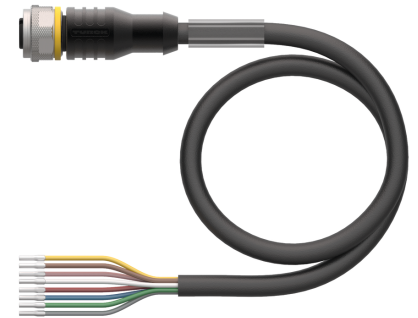
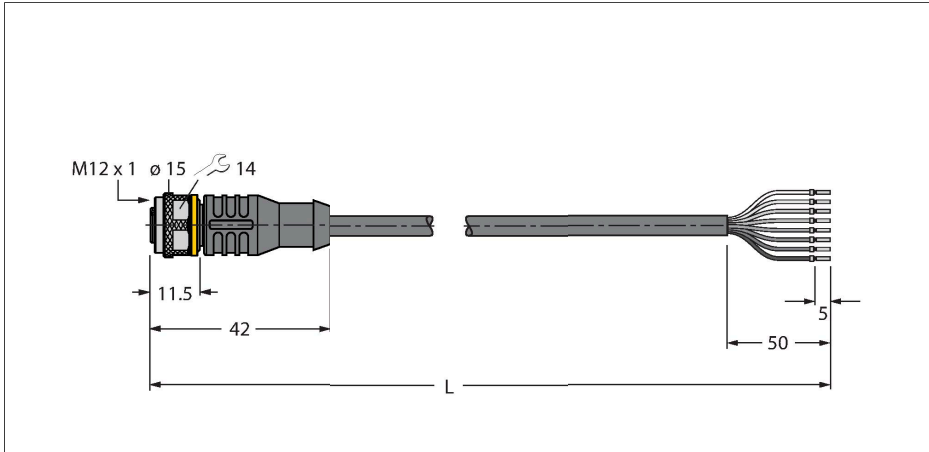

### Technical data

Type	RKC8.800T-40/TXL
ID	6638209
Connector A	Female, M12 × 1, Straight, A-coded
Number of pins	8
Contacts	Brass, CuZn, Gold-plated
Contact carriers	Plastic, TPU, Black
Connector body	Plastic, TPU, Black
Coupling nut/screw	Brass, CuZn, Nickel-plated
Seal	Plastic, FPM/FKM
Mechanical lifespan	> 100 Mating cycles
Pollution degree	3
Protection class	IP67, IP69K, Only in screwed condition
<b>Cable</b>	
Cable diameter	Ø 5.8 mm ±0.20
Cable length	40 m
Cable jacket	PUR, Black
Core insulation	PP
Core cross-section	8 x 0.25 mm <sup>2</sup>
Arrangement of strands	32 x 0.1 mm
Core colors	WH, BN, GN, YE, GY, PK, BU, RD
<b>Electrical properties at +20 °C</b>	
Rated voltage	30 V
Test voltage	2000 V
Current	2 A
Insulation resistance	> 30.5 MΩ/km
forward resistance	max. 79 Ω/km

### Features



- Female M12, straight, 8-pin
- Jacket material: PUR
- Jacket color: black
- Suitable for drag chain use
- Resistant to chemicals, UV radiation and oils
- Flame retardant (FT2 acc. to UL 1581, IEC 60332-2-2)
- Resistant to welding sparks
- Free from halogen, silicone, PVC and LABS
- Particularly resistant to abrasion
- Protection class: IP67, IP69K
- Cable length: 40 m

### Cable Cross-Section

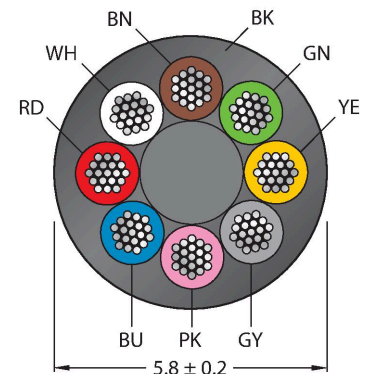

### Contact assignment

## Technical data

Mechanical and chemical properties	
Bending radius (stationary installation)	$\geq 5 \times \varnothing$
Bending radius (flexible use)	$\geq 10 \times \varnothing$
Bending cycles	$\geq 5$ million
Admissible acceleration	max. 5 m/s <sup>2</sup>
Admissible travel path, horizontal	5 m (at 5 m/s <sup>2</sup> )
Admissible travel path, vertical	2 m (at 5 m/s <sup>2</sup> )
Admissible traversing speed	3.3 m/s
Torsional stress	$\pm 180$ °/m
Ambient temperature (fixed)	-50...+80 °C
Ambient temperature (mobile)	-25...+80 °C
Ambient temperature (drag chain)	-25...+60 °C
Approvals	cULus

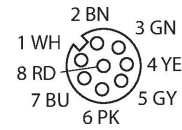

## Circuit Diagram

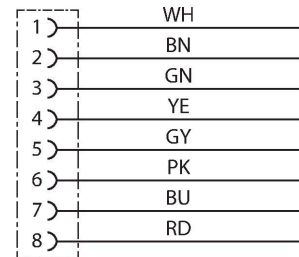

## Accessories

**TORQUE-WRENCH-SET-AS** 6936170

Torque wrench set; handles with adjustable torque 0.4-1.0 Nm, torque wrench for M8 (SW9), fork wrench for M12 (SW 14)

**BLANK-LABEL-FOR-CORDSETS-TEL-TXL** 6936206

Label for TEL and TXL cables, length: 18 mm, height: 4 mm, material: polycarbonate (PC), color: white, halogen-free and flame-retardant

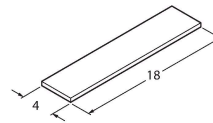

**BS8181-0** 6901004

Field-wireable male connector, M12 x 1, straight, 8-pin, screw terminal connection, cable feedthrough 6.0 to 8.0 mm, core cross-section/terminal capacity 0.14 to 0.50 mm<sup>2</sup>, plastic housing, metal retaining screw

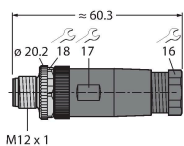

**BS8281-0** 6930862

Field-wireable male connector, M12 x 1, angled, 8-pin, screw terminal connection, cable feedthrough 6.0 to 8.0 mm, core cross-section/terminal capacity 0.14 to 0.50 mm<sup>2</sup>, plastic housing, metal retaining screw

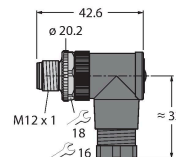

**CMBS8181-0** 6930792

Field-wireable male connector, M12 x 1, straight, 8-pin, screw terminal connection, cable feedthrough 6.0 to 8.0 mm, core cross-section/terminal capacity 0.14 to 0.50 mm<sup>2</sup>, metal housing, metal nut, shieldable, also for Ethernet

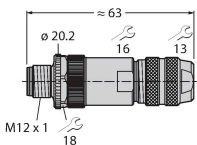

## Accessories

Dimension drawing	Type	ID	
	LABEL-HOLDER-FLEX-PVC	100048170	PVC label holder for identification of extension cables (TEL/TXL product series); for cable diameters: min. 5 mm; dimensions 4 × 18 mm; delivery unit: 50 pcs. per package