

RKS4.5T-5/TXY3013

Actuator and Sensor Cable, PUR – Connection Cable

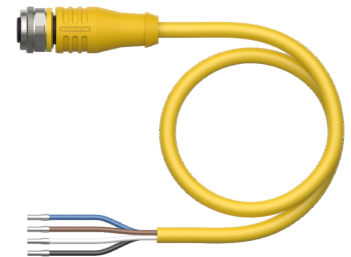
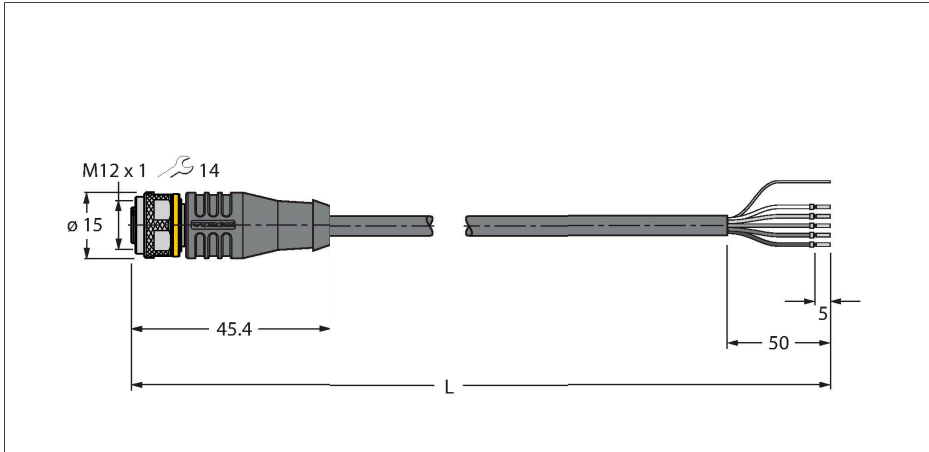

Technical data

Type	RKS4.5T-5/TXY3013
ID	6631078
Connector A	Female, M12 × 1, Straight, A-coded
Number of pins	5
Contacts	Brass, CuZn, Gold-plated
Contact carriers	Plastic, TPU, Black
Connector body	Plastic, TPU, Yellow
Coupling nut/screw	Brass, CuZn, Nickel-plated
Seal	Plastic, FPM/FKM
Mechanical lifespan	> 100 Mating cycles
Pollution degree	3
Protection class	IP67, IP69K, Only in screwed condition
Cable	
Cable diameter	Ø 5.7 mm ±0.20
Cable length	5 m
Cable jacket	PUR, Yellow
Shielding	Aluminum foil, tinned copper wire
Core insulation	PP
Core cross-section	5 x 0.34 mm ²
Arrangement of strands	42 x 0.1 mm
Core colors	BN, WH, BU, BK, GY
Electrical properties at +20 °C	
Rated voltage	60 V
Test voltage	2000 V
Current	4 A
Insulation resistance	> 30.5 MΩ/km
forward resistance	max. 57 Ω/km

Features



- Female M12, straight, 5-pin
- Shield on coupling nut/screw
- Jacket material: PUR
- Jacket color: yellow
- Grip color: yellow
- Suitable for drag chain use
- Resistant to chemicals, UV radiation and oils
- Flame retardant (FT2 acc. to UL 1581, IEC 60332-2-2)
- Free from halogen, silicone, PVC and LABS
- Particularly resistant to abrasion
- Protection class: IP67, IP69K
- Cable length: 5.0 m

Cable Cross-Section

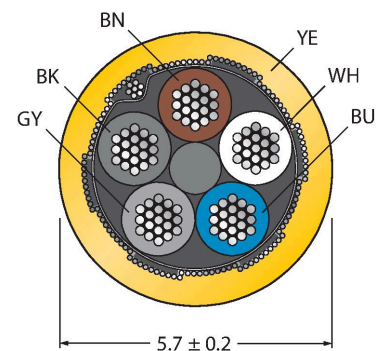

Contact assignment

Technical data

Mechanical and chemical properties	
Bending radius (stationary installation)	≥ 5 x Ø
Bending radius (flexible use)	≥ 10 x Ø
Bending cycles	≥ 5 million
Admissible acceleration	max. 5 m/s ²
Admissible travel path, horizontal	5 m (at 5 m/s ²)
Admissible travel path, vertical	2 m (at 5 m/s ²)
Admissible traversing speed	3.3 m/s
Torsional stress	± 180 °/m
Ambient temperature (fixed)	-50...+80 °C
Ambient temperature (mobile)	-25...+80 °C
Ambient temperature (drag chain)	-25...+60 °C
Approvals	cULus

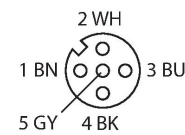

Circuit Diagram

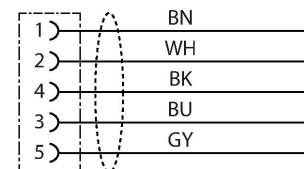

Accessories

CMBS8151-0

6930161

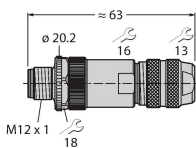

Field-wireable male connector, M12 × 1, straight, 5-pin, screw terminal connection, cable feedthrough 6.0 to 8.0 mm, core cross-section/terminal capacity 0.14 to 0.75 mm², metal housing, metal nut, shieldable

CMBS8251-0

6930216

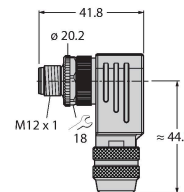

Field-wireable male connector, M12 × 1, angled, 5-pin, screw terminal connection, cable feedthrough 6.0 to 8.0 mm, core cross-section/terminal capacity 0.14 to 0.75 mm², metal housing, metal nut, shieldable

TORQUE-WRENCH-SET-AS

6936170

Torque wrench set; handles with adjustable torque 0.4-1.0 Nm, torque wrench for M8 (SW9), fork wrench for M12 (SW 14)

BLANK-LABEL-FOR-CORDSETS-TEL-TXL

6936206

Label for TEL and TXL cables, length: 18 mm, height: 4 mm, material: polycarbonate (PC), color: white, halogen-free and flame-retardant

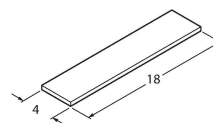

Accessories

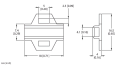
Dimension drawing	Type	ID	
	LABEL-HOLDER-FLEX-PVC	100048170	PVC label holder for identification of extension cables (TEL/TXL product series); for cable diameters: min. 5 mm; dimensions 4 × 18 mm; delivery unit: 50 pcs. per package