

# Industrial Ethernet/PROFINET Cable Extension Cable RSSD-RSSD-4416-35M

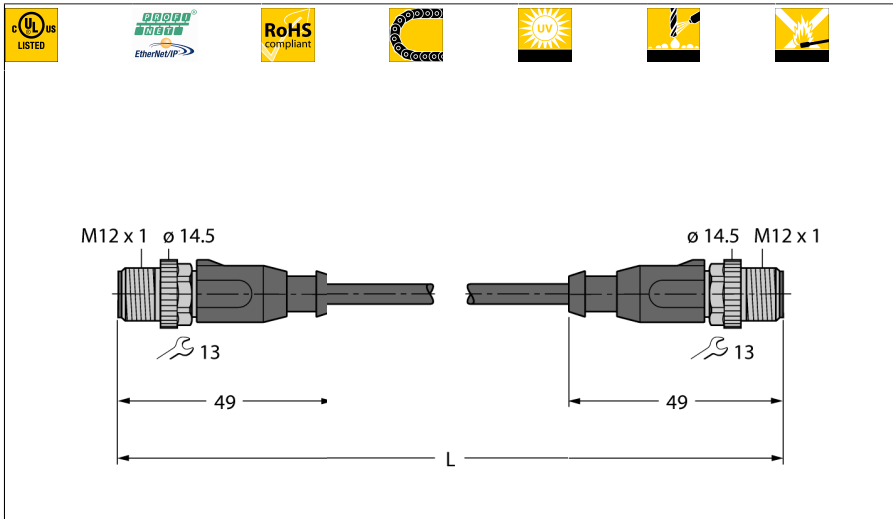

- Ethernet cable: 4-pin, AWG 22
- CAT 5E
- Jacket material: PUR
- Jacket color: green
- Shielding: overlapping aluminum foil, tinned copper wire
- Jacket diameter: 6.5 mm
- Suitable for drag chain use
- Oil resistant acc. to IEC 60811-2-1 and UL13
- Halogen free acc. to IEC 60754
- Flame retardant acc. to IEC 60332-1-2 and UL2556 VW1
- Approval: UL
- RoHS compliant
- PNO compliant
- M12 male, straight
- M12 male connector, straight, D-coded
- Cable length: 35 m

Type	RSSD-RSSD-4416-35M
ID	6441667

Connector A	Male, M12 × 1, Straight, D-coded
Number of pins	4
Contact carriers	Plastic, PA, UL 94, Black
Connector body	Plastic, TPU, UL 94, Black
Coupling nut/screw	Brass, GD-Zn, Nickel-plated
Tightening torque (range)	0.4 ... 0.6 Nm (observe max. torque of mating connector!)
Mechanical lifespan	> 100 Mating cycles
Pollution degree	3/2
Protection class	IP67, Only in screwed condition

Connector B	Male, M12 × 1, Straight, D-coded
Number of Pins	4
Contact carriers	Plastic, PA, UL 94, Black
Connector body	Plastic, TPU, UL 94, Black
Coupling nut/retaining screw	Brass, GD-Zn, Nickel-plated
Tightening torque	0.4 ... 0.6 Nm (observe max. torque of mating connector!)
Mechanical life	> 100 Mating cycles
Pollution degree	3/2
Protection class	IP67, Only when screwed together

Cable	
Network protocol	Ethernet
Cable diameter	Ø 6.5mm ±0.20
Cable length	35 m m
Cable jacket	PUR, Green
Shielding	Aluminum foil, tinned copper wire
Core insulation	PE
Core cross-section	4 x 0.32 mm <sup>2</sup>
Arrangement of strands	7 x 0.25mm
Core colors	WH, YE, BU, OG

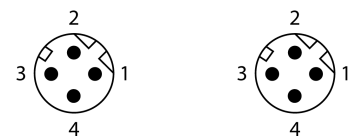

### Circuit Diagram

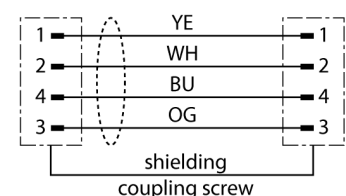

**Electrical properties at +20 °C**

Rated voltage	48V
Test voltage	2000 V
Current	3AA
DC resistance (loop)	120 Ω/km
Nom. impedance	100 Ω (1MHZ)
Nom. capacitance	50 pF/m

**Mechanical and chemical properties**

Bending radius (stationary installation)	≥ 5 x Ø
Bending radius (flexible use)	≥ 15 x Ø
Bending cycles	≥ 3 million
Torsional stress	± 180 °/m
Torsion cycles	Max. 100,000
Ambient temperature (fixed)	-50...+70°C
Ambient temperature (mobile)	-20...+60°C

**Other Features**

Qualified for drag chain use	yes
Halogen-free	yes
PVC-free	yes
UV resistance	yes
Oil-resistant	yes
Flame-retardant	yes

**Accessories**

Type code	Ident no.		Dimension drawing
TORQUE-WRENCH-SET-BUS	6936171	Torque wrench set; grip with adjustable torque 0.4 to 1.0 Nm; torque wrench set, fork wrench for M8 (SW9), fork wrench for M12 (SW13), fork wrench for M12 (SW14)	