

QS18VP6LLP W/30

Photoelectric Sensor – Retroreflective Laser Sensor with Polarizing Filter

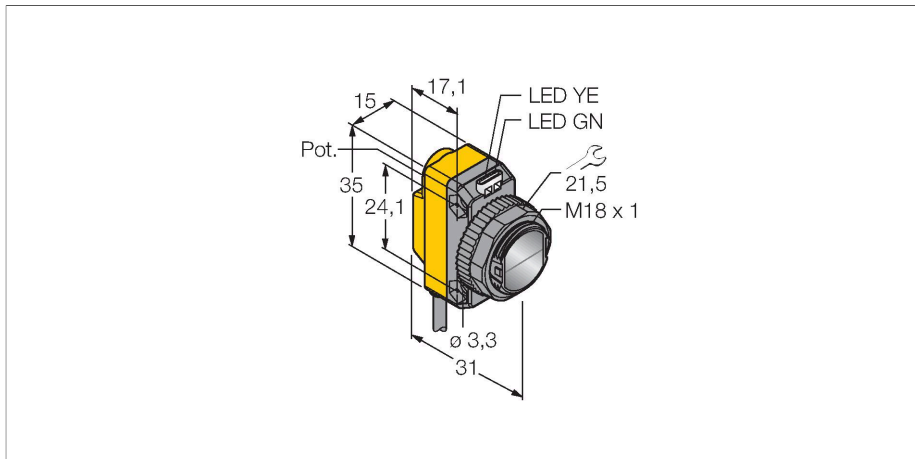

Technical data

Type	QS18VP6LLP W/30
ID	3073242
Optical data	
Function	Retroreflective Sensor
Operating mode	Polarized
Reflector included in delivery	yes
Light type	Red polarized
Wavelength	650 nm
Laser class	▲ 1
Beam diameter	4 at 10000 mm
Range	100...10000 mm
Electrical data	
Operating voltage	10...30 VDC
Residual ripple	< 10 % U _{ss}
DC rated operational current	≤ 100 mA
Short-circuit protection	yes
Reverse polarity protection	yes
Output function	NO/NC, PNP
Current output	100 mA
Switching frequency	≤ 700 Hz
Readiness delay	≤ 200 ms
Response time typical	< 0.7 ms
Setting option	Potentiometer
Mechanical data	
Design	Rectangular with thread, QS18
Dimensions	Ø 18 x 31 x 15 x 35 mm

Features

- Cable, PVC, 9 m
- Protection class IP67
- LED, all-round visible
- Sensitivity adjusted via potentiometer
- Microprism reflector BRT-51X51BM recommended for ranges up to 10 m and self-adhesive reflector film BRT-TVHG-2X2 for ranges up to 1.5 m; included in scope of delivery
- Operating voltage: 10...30 VDC
- PNP switching output, changeover

Wiring diagram

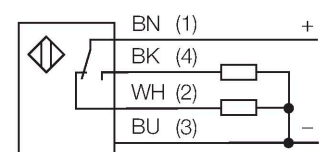

Functional principle

Retro-reflective sensors incorporate emitter and receiver in the same compact housing. The light beam of the emitter is directed towards a reflector which returns the light back to the receiver. An object is detected when it interrupts this beam. Retro-reflective sensors incorporate some of the advantages of opposed mode sensors (good contrast and high excess gain). Further it is merely required to install and wire a single device. A smaller sensing range and susceptibility of devices without polarisation filter can be of disadvantage when shiny objects have to be detected.

Excess gain curve
Excess gain in relation to the distance (reflector type BRT-51X51BM)

Technical data

Housing material	Plastic, ABS
Lens	plastic, Acrylic
Electrical connection	Cable, 9 m, PVC
Number of cores	4
Core cross-section	0.35 mm ²
Ambient temperature	-10...+50 °C
Protection class	IP67
Special features	Laser
Power-on indication	LED, Green
Switching state	LED, Yellow
Error indication	LED, green, Flashing
Excess gain indication	LED, yellow, flashing
Tests/approvals	
Approvals	CE, cURus

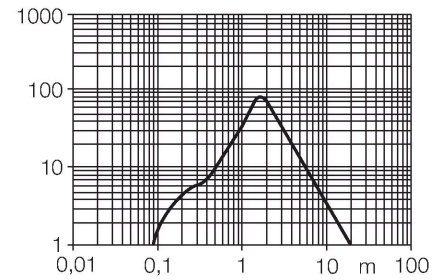

Accessories

SMB18A

3033200

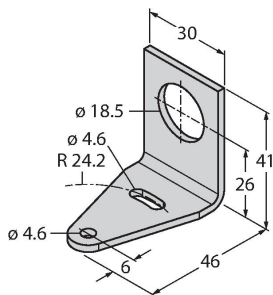

Mounting bracket, rectangular, stainless steel, for sensors with 18 mm thread

SMB18AFAM10

3012558

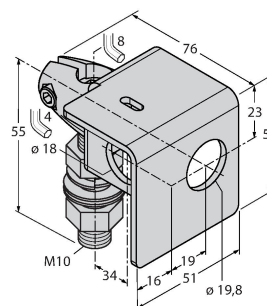

Mounting bracket, material VA 1.4401, for M10 x 1.5 thread, thread length 18 mm

SMBQS18A

3069721

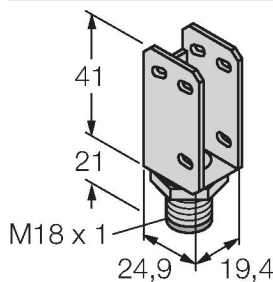

Mounting bracket, stainless steel, for 18 mm thread

SMB18SF

3052519

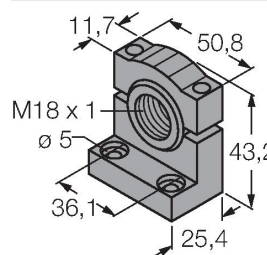

Mounting bracket, PBT black, for sensors with 18 mm thread, rotatable

Accessories

Dimension drawing	Type	ID	
	BRT-51X51BM	3071791	Rectangular reflector, reflection coefficient 2.0, material acrylic, ambient temperature -20 ... +60 °C, microprism geometry

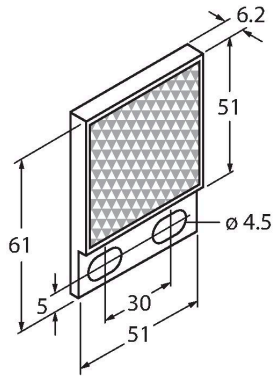

	BRT-TVHG2X2	3057260	Rectangular reflective foil, reflection coefficient 0.8, ambient temperature -20 ... +60 °C, 4 sheets
--	-------------	---------	---

