

DWE-40000-135-10-2B2000-H1181

Draw-Wire

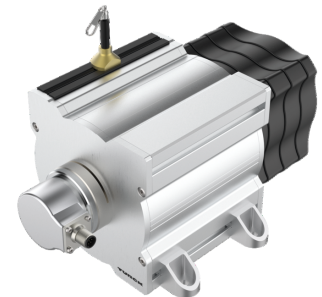
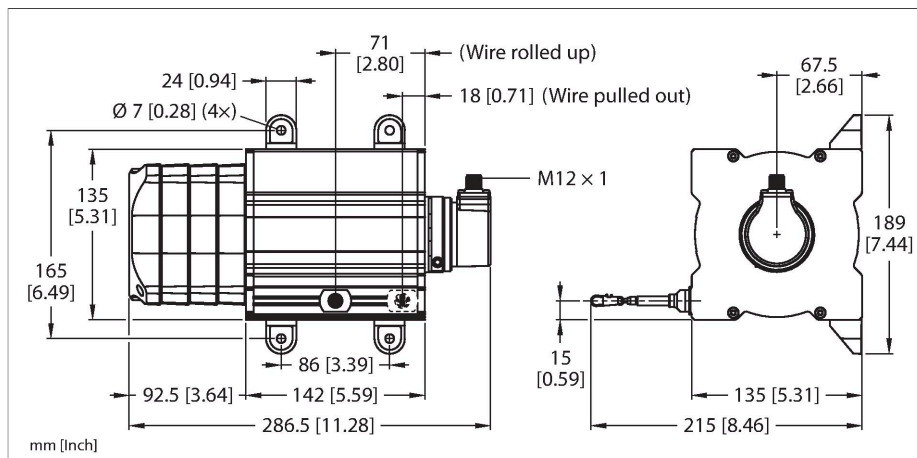

Technical data

Type	DWE-40000-135-10-2B2000-H1181
ID	100049406
Measuring principle	Optical
General data	
Measuring range	40000 mm
Linearity deviation	≤ 0.05 %
Output type	Incremental
Electrical data	
Operating voltage U_B	10...30 VDC
No-load current	≤ 100 mA
Output current	≤ 30 mA
Short-circuit protection	yes
Pulse frequency max.	300 kHz
Signal level high	min. $U_B - 1 V$
Signal level low	max. 0.5 V
Output function	8-wire, Push-Pull/HTL, invertable
Mechanical data	
Design	Draw Wire
Housing material	Titanium anodized aluminium
Encoder housing material	Die-cast zinc
min. extension force	7 N
max. extension force	14.1 N
max. extension speed	5 m/s
Pull acceleration max.	60 m/s ²
wire material	Stainless steel
Electrical connection	Connector, M12 × 1

Features

- Draw-wire sensor for large measuring lengths
- With permanently installed incremental encoder
- Measuring principle: optical
- Sensor protection class IP65
- -20...+85 °C
- 10...30 VDC
- Push-pull/HTL with inversion
- Pulse frequency max. 300 kHz
- M12 × 1 connector, 8-pin

Wiring diagram

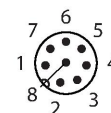
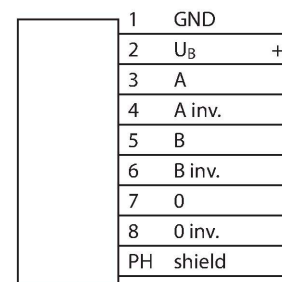

Technical data

Environmental conditions

Ambient temperature	-20...+85 °C
Protection class	IP65

Accessories

RDR-1**1544753**

Deflection roller for aluminium draw-wire sensors

