

LI1500P0-Q25LM0-ELIU5X3-H1151

Inductive Linear Position Sensor



Technical data

Type	LI1500P0-Q25LM0-ELIU5X3-H1151
ID	100001318
Measuring principle	Inductive
General data	
Measuring range	1500 mm
Resolution	16 bit
Nominal distance	1.5 mm
Blind zone a	29 mm
Blind zone b	29 mm
Repeat accuracy	≤ 0.02 % of full scale
Linearity deviation	≤ 0.05 % f.s. also under the influence of shock and vibration
Temperature drift	≤ ± 0.003 %/K
Hysteresis	omitted as a matter of principle
Electrical data	
Operating voltage	15...30 VDC
Residual ripple	≤ 10 % U _{ss}
Isolation test voltage	≤ 0.5 kV
Short-circuit protection	yes
Wire breakage/Reverse polarity protection	yes / yes (voltage supply)
Output function	5-pin, Analog output
Voltage output	0...10 V
Current output	4...20 mA
Diagnostic	Positioning element not within detection range: Output signal 24 mA or 11 V
Load resistance voltage output	≥ 4.7 kΩ
Load resistance current output	≤ 0.4 kΩ

Features

- Rectangular, aluminium / plastic
- Versatile mounting possibilities
- Measuring range displayed via LED
- Immune to electromagnetic interference
- Extremely short blind zones
- Resolution, 16-bit
- 4-wire, 15...30 VDC
- Analog output
- Programmable measuring range
- 0...10 V and 4...20 mA, improved machine safety possible through redundancy
- M12 × 1 connector, 5-pin

Wiring diagram

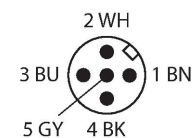
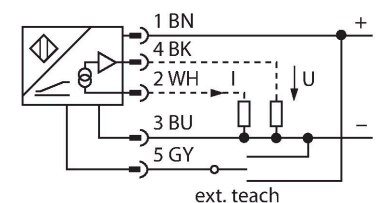

Functional principle

The measuring principle of linear position sensors is based on RLC coupling between the positioning element and the sensor, whereby an output signal is provided proportional to the position of the positioning element. The rugged sensors are wear and tear-free, thanks to the contactless operating principle. They convince through their excellent repeatability, resolution and linearity within a broad temperature range.

Technical data

Sample rate	5000 Hz
Current consumption	< 100 mA
Mechanical data	
Design	Profile, Q25L
Dimensions	1558 x 35 x 25 mm
Housing material	Aluminum/plastic, PA6-GF30, Anodized
Active area material	Plastic, PA6-GF30
Electrical connection	Connector, M12 × 1
Environmental conditions	
Ambient temperature	-25...+70 °C
Vibration resistance (EN 60068-2-6)	20 g; 1.25 h/axis; 3 axes
Shock resistance (EN 60068-2-27)	200 g; 4 ms ½ sine
Protection class	IP66 IP67
MTTF	138 years acc. to SN 29500 (Ed. 99) 40 °C
Power-on indication	LED, Green
Measuring range display	multifunction LED, green, yellow, yellow flashing

The innovative technology ensures a high immunity to electromagnetic DC and AC fields.

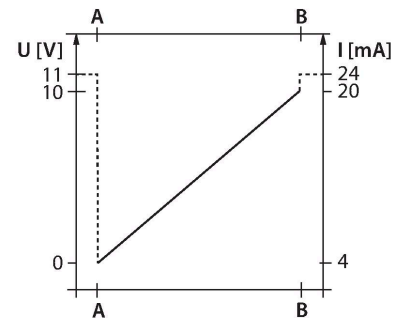

Mounting instructions

Mounting instructions/Description

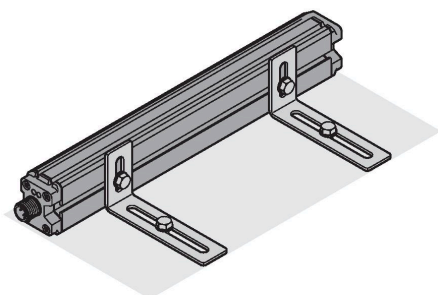
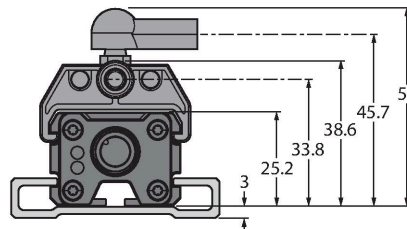
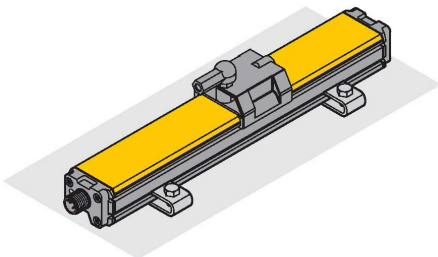

Extensive mounting accessories provide various options for installation. Due to the measuring principle, which is based on the functional principle of an RLC coupling, the linear position sensor is immune to magnetized metal splinters and other interferences.

Status display via LED

Green:

Sensor is supplied properly

LED indicates measuring range

Green:

Positioning element is within the measuring range

Yellow:

Positioning element is within the measuring range, low signal intensity (e.g. distance too large)

Yellow flashing:

Positioning element is outside the detection range

Off:

Positioning element is outside the programmed range (only with teachable versions)

Teaching

The start and end point of the measuring range are set by pressing the button on the teach adapter. Moreover there is the possibility of inverting the course of the output curve.

Zero/Span

Bridge pin 5 and pin 3 for 2 s = sets start value of measuring range

After 2 seconds the green LED is illuminated continuously

Bridge pin 5 and pin 1 for 2 s = sets end value of measuring range

After 2 seconds the green LED is illuminated continuously

Factory setting

Bridge pin 5 and pin 1 for 10 s = factory setting

After 10 seconds the green LED flashes green

Bridge pin 5 and pin 3 for 10 s = factory setting inverted

After 10 seconds the green LED flashes green

Optional:

Bridge pin 5 and pin 1 for 30 s = teach lock active/inactive

After 30 s. the flashing changes to fast flashing

The configured settings do not need to be locked using the teach lock because as a general rule they are saved in the sensor's non-volatile memory even after power is lost. The teach lock is recommended in situations where it is necessary to prevent subsequent alteration of the parameters.

Accessories

P1-LI-Q25L

6901041

Guided positioning element for linear position sensors LI-Q25L, inserted in the groove of the sensor

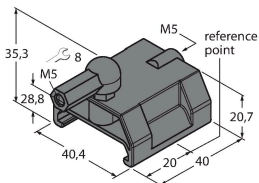

P2-LI-Q25L

6901042

Floating positioning element for linear position sensors LI-Q25L; the nominal distance to the sensor is 1.5 mm; pairing with the linear position sensor at a distance of up to 5 mm or misalignment tolerance of up to 4 mm.

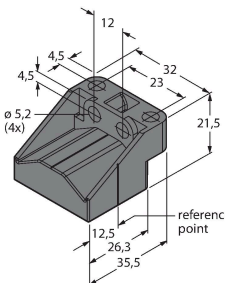

P3-LI-Q25L

6901044

Floating positioning element for Li-Q25L linear position sensors; operational at an offset of 90°; nominal distance to sensor 1.5 mm; pairing with linear position sensor at a distance of up to 5 mm; misalignment tolerance of up to 4 mm

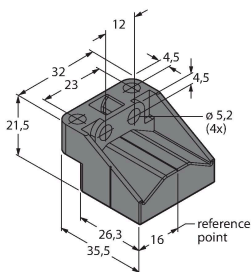

P6-LI-Q25L

6901069

Floating positioning element for linear position sensors LI-Q25L; the nominal distance to the sensor is 1.5 mm; pairing with the linear position sensor at a distance of up to 5 mm or misalignment tolerance of up to 4 mm.

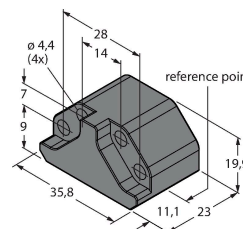

P7-LI-Q25L

6901087

Guided positioning element for linear position sensors LI-Q25L, without ball joint



M1-Q25L (2 PCS)

6901045

Mounting foot for linear position sensors LI-Q25L; material: aluminum; 2 pcs. per bag

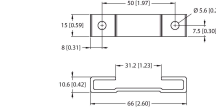

M2-Q25L

6901046

Mounting foot for linear position sensors LI-Q25L; material: aluminum; 2 pcs. per bag

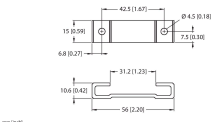

M4-Q25L

6901048

Mounting bracket and sliding block for linear position sensors LI-Q25L; material: Stainless steel; 2 pcs. per bag

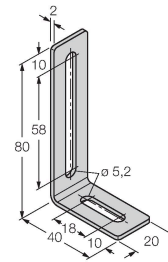

MN-M4-Q25

6901025

Sliding block with M4 thread for the backside profile of the LI-Q25L; material: galvanized steel; 10 pcs. per bag

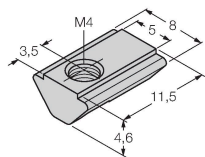

AB-M5

6901057

Axial Joint for Guided Positioning Elements



ABVA-M5

6901058

Axial joint for guided positioning element, stainless steel



RBVA-M5

6901059

Angle joint for guided positioning element, stainless steel

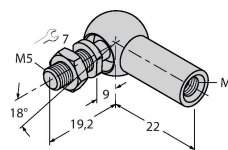

Accessories

Dimension drawing	Type	ID	
-------------------	------	----	--

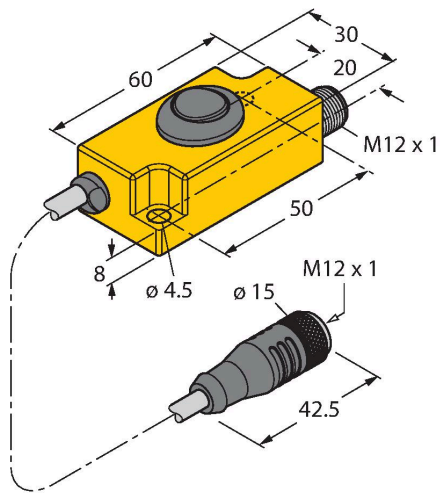

TX1-Q20L60

6967114

Teach adapter for inductive encoders, linear position, angle, ultrasonic and capacitive sensors